

Basic-type Digital Temperature Controller E5CN/E5CN-U (48 x 48 mm)

New 48 x 48-mm Basic Temperature Controller with Enhanced Functions and Performance. Improved Indication Accuracy and Preventive Maintenance Function.

- Indication Accuracy
 Thermocouple input: $\pm 0.3\%$ of PV (previous models: $\pm 0.5\%$)
 Pt input: $\pm 0.2\%$ of PV (previous models: $\pm 0.5\%$)
 Analog input: $\pm 0.2\%$ FS (previous models: $\pm 0.5\%$)
- New E5CN-U Models (Plug-in Models) with analog inputs and current outputs.
- A PV/SV-status display function can be set to automatically alternate between displaying the status of the Temperature Controller (auto/manual, RUN/STOP, and alarms) and the PV or SV.
- Preventive maintenance for relays in the Temperature Controller using a Control Output ON/OFF Counter.



E5CN
E5CN-U (48 x 48 mm)

E5AN (96 x 96 mm)
E5EN (48 x 96 mm)

NEW

Refer to *Safety Precautions* on page 66.

E5CN-H (48 x 48 mm)

Main I/O Functions

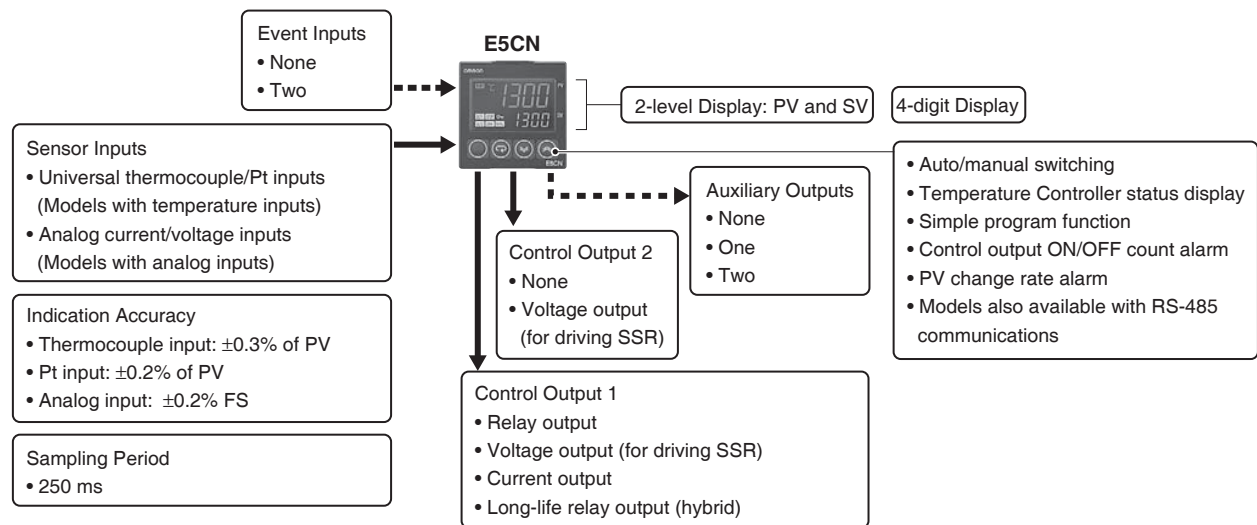

E5AN-H (96 x 96 mm)
E5EN-H (48 x 96 mm)

Operation

This data sheet is provided as a guideline for selecting products. Be sure to refer to the following user manuals for application precautions and other information required for operation before attempting to use the product.
 E5CN/E5AN/E5EN Digital Temperature Controllers User's Manual Basic Type (Cat. No. H156)
 E5CN/E5AN/E5EN Digital Temperature Controllers Communications Manual Basic Type (Cat. No. H158)

Safety Precautions

E5CN/E5CN-U

Lineup

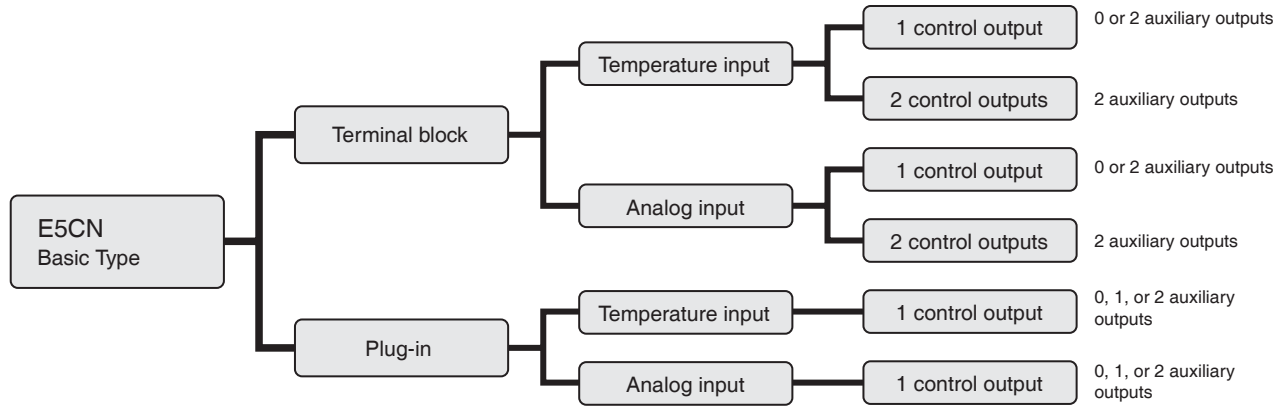

Note: Models with one control output and one or two auxiliary outputs and models with two control outputs can be used for heating/cooling control.

Model Number Structure

Model Number Legend

Controllers

E5CN- M - -500
 1 2 3 4 5 6 7

1. Control Output 1

- R: Relay output
- Q: Voltage output (for driving SSR)
- C: Current output
- Y: Long-life relay output (hybrid) *1

2. Auxiliary Outputs *2

- Blank: None
- 2: Two outputs

3. Option

- M: Option Unit can be mounted.

4. Input Type

- T: Universal thermocouple/platinum resistance thermometer
- L: Analog current/voltage input

5. Power Supply Voltage

- Blank: 100 to 240 VAC
- D: 24 VAC/VDC

6. Case Color

- Blank: Black
- W: Silver

7. Terminal Cover

- 500: With terminal cover

Option Units

E53-CN
 1 2 3 4

1. Applicable Controller

- CN: E5CN or E5CN-H

2. Function 1

- Blank: None
- Q: Control output 2 (voltage for driving SSR)
- P: Power supply for sensor

3. Function 2

- Blank: None
- H: Heater burnout/SSR failure/Heater overcurrent detection (CT1)
- HH: Heater burnout/SSR failure/Heater overcurrent detection (CT2)
- B: Two event inputs
- 03: RS-485 communications
- H03: Heater burnout/SSR failure/Heater overcurrent detection (CT1) + RS-485 communications
- HB: Heater burnout/SSR failure/Heater overcurrent detection (CT1) + Two event inputs
- HH03: Heater burnout/SSR failure/Heater overcurrent detection (CT2) + RS-485 communications

4. Version

- N2: Applicable only to models released after January 2008

Note: Not all combinations of function 1 and function 2 specifications are possible for Option Units (E53-□□□□).

*1. Always connect an AC load to a long-life relay output. The output will not turn OFF if a DC load is connected because a triac is used for switching the circuit. For details, check the conditions in *Ratings*.

*2. Auxiliary outputs are contact outputs that can be used to output alarms or results of logic operations.

E5CN (96 x 96 mm)
E5CN-U (48 x 48 mm)

E5AN (96 x 96 mm)
E5EN (48 x 96 mm)

E5CN-H (48 x 48 mm)

E5AN-H (96 x 96 mm)
E5EN-H (48 x 96 mm)

Operation

Safety Precautions

Ordering Information

Controllers with Terminal Blocks

Size	Case color	Power supply voltage	Input type	Auxiliary outputs	Control output 1	Model		
1/16 DIN 48 × 48 × 78 (W × H × D)	Black	100 to 240 VAC	Thermocouple or Resistance thermometer	None	Relay output	E5CN-RMT-500		
					Voltage output (for driving SSR)	E5CN-QMT-500		
					Current output	E5CN-CMT-500		
				2	Relay output	E5CN-R2MT-500		
					Voltage output (for driving SSR)	E5CN-Q2MT-500		
					Current output	E5CN-C2MT-500		
		24 VAC/VDC	Thermocouple or Resistance thermometer	None	Relay output	E5CN-RMTD-500		
					Voltage output (for driving SSR)	E5CN-QMTD-500		
					Current output	E5CN-CMTD-500		
				2	Relay output	E5CN-R2MTD-500		
					Voltage output (for driving SSR)	E5CN-Q2MTD-500		
					Current output	E5CN-C2MTD-500		
	Silver	100 to 240 VAC	Analog (current/voltage)	None	Relay output	E5CN-RML-500		
					Voltage output (for driving SSR)	E5CN-QML-500		
					Current output	E5CN-CML-500		
				2	Relay output	E5CN-R2ML-500		
					Voltage output (for driving SSR)	E5CN-Q2ML-500		
					Current output	E5CN-C2ML-500		
		24 VAC/VDC	Analog (current/voltage)	2	Relay output	E5CN-R2MLD-500		
					Voltage output (for driving SSR)	E5CN-Q2MLD-500		
					Current output	E5CN-C2MLD-500		
				100 to 240 VAC	Thermocouple or Resistance thermometer	None	Relay output	E5CN-RMT-W-500
							Voltage output (for driving SSR)	E5CN-QMT-W-500
							Current output	E5CN-CMT-W-500
2	Relay output	E5CN-R2MT-W-500						
	Voltage output (for driving SSR)	E5CN-Q2MT-W-500						
	Current output	E5CN-C2MT-W-500						
24 VAC/VDC	Thermocouple or Resistance thermometer	2	Relay output	E5CN-R2MTD-W-500				
			Voltage output (for driving SSR)	E5CN-Q2MTD-W-500				
			Current output	E5CN-C2MTD-W-500				

E5CN
E5CN-U (48 x 48 mm)

E5AN (96 x 96 mm)
E5EN (48 x 96 mm)

E5CN-H (48 x 48 mm)

E5AN-H (96 x 96 mm)
E5EN-H (48 x 96 mm)

Option Units

One of the following Option Units can be mounted to provide the E5CN with additional functions.

Functions	Model
Communications RS-485 3-phase heater burnout/SSR failure/ Heater overcurrent detection	E53-CNHH03N2
Heater burnout/SSR failure/Heater overcurrent detection Event inputs	E53-CNHBN2
Communications RS-485 Control output 2 (Voltage for driving SSR)	E53-CNQ03N2
Event inputs External power supply for ES1B	E53-CNPBN2
Heater burnout/SSR failure/Heater overcurrent detection External power supply for ES1B	E53-CNPHN2
Communications RS-485 External power supply for ES1B	E53-CNP03N2
Communications RS-485 Heater burnout/SSR failure/Heater overcurrent detection	E53-CNH03N2
Communications RS-485 Event inputs	E53-CN03N2
Event inputs	E53-CNBN2
Heater burnout/SSR failure/Heater overcurrent detection Control output 2 (Voltage for driving SSR)	E53-CNQHN2
3-phase heater burnout/SSR failure/ Heater overcurrent detection Control output 2 (Voltage for driving SSR)	E53-CNQHHN2
Event inputs Control output 2 (Voltage for driving SSR)	E53-CNQBN2

Operation

Safety Precautions

Note: Option Units cannot be used for plug-in models. These Option Units are applicable only to models released after January 2008.

E5CN/E5CN-U

Model Number Structure

Model Number Legend (Plug-in-type Controllers)

E5CN-□□□□U
1 2 3 4

1. Output Type

- R: Relay output
- Q: Voltage output (for driving SSR)
- C: Current output

2. Number of Alarms

- Blank: No alarm
- 1: One alarm
- 2: Two alarms

3. Input Type

- T: Universal thermocouple/platinum resistance thermometer
- L: Analog Input

4. Plug-in type

- U: Plug-in type

Ordering Information

Plug-in-type Controllers

Size	Case color	Power supply voltage	Input type	Auxiliary outputs	Control output 1	Model	
1/16 DIN	Black	100 to 240 VAC	Thermocouple or resistance thermometer	None	Relay output	E5CN-RTU	
					Voltage output (for driving SSR)	E5CN-QTU	
					Current output	E5CN-CTU	
				1	Relay output	E5CN-R1TU	
					Voltage output (for driving SSR)	E5CN-Q1TU	
					Current output	E5CN-C1TU	
		2	Relay output	E5CN-R2TU			
			Voltage output (for driving SSR)	E5CN-Q2TU			
			Current output	E5CN-C2TU			
		24 VAC/VDC	Thermocouple or resistance thermometer	Analog (current/voltage)	1	Relay output	E5CN-R1LU
						Voltage output (for driving SSR)	E5CN-Q1LU
						Current output	E5CN-C1LU
2	Relay output				E5CN-R2LU		
	Voltage output (for driving SSR)				E5CN-Q2LU		
	Current output				E5CN-C2LU		
None	Thermocouple or resistance thermometer	None	None	Relay output	E5CN-RTDU		
				Voltage output (for driving SSR)	E5CN-QTDU		
				Current output	E5CN-CTDU		
			1	Relay output	E5CN-R1TDU		
				Voltage output (for driving SSR)	E5CN-Q1TDU		
				Current output	E5CN-C1TDU		
			2	Relay output	E5CN-R2TDU		
				Voltage output (for driving SSR)	E5CN-Q2TDU		
				Current output	E5CN-C2TDU		

E5CN (48 x 48 mm)
E5CN-U (48 x 48 mm)

E5AN (96 x 96 mm)
E5EN (48 x 96 mm)

E5CN-H (48 x 48 mm)

E5AN-H (96 x 96 mm)
E5EN-H (48 x 96 mm)

Operation

Safety Precautions

Accessories (Order Separately)

USB-Serial Conversion Cable

Model
E58-CIFQ1

Terminal Cover

Connectable models	Terminal block models
Model	E53-COV17

Note: The Terminal Cover comes with the E5CN-□□□-500 models.

Waterproof Packing

Model
Y92S-29

Note: The Waterproof Packing is included with the Controller only for models with terminal blocks.

Current Transformers (CTs)

Hole diameter	Model
5.8 dia.	E54-CT1
12.0 dia.	E54-CT3

Adapter

Connectable models	Model
Terminal block models	Y92F-45

Note: Use this Adapter when the panel has been previously prepared for the E5B□.

Sockets (for Plug-in Models)

Type	Model
Front-connecting Socket	P2CF-11
Front-connecting Socket with Finger Protection	P2CF-11-E
Back-connecting Socket	P3GA-11
Terminal Cover for Back-connecting socket with Finger Protection	Y92A-48G

CX-Thermo Support Software

Model
EST2-2C-MV4

E5CN
E5CN-U (48 x 48 mm)

E5AN (96 x 96 mm)
E5EN (48 x 96 mm)

E5CN-H (48 x 48 mm)

E5AN-H (96 x 96 mm)
E5EN-H (48 x 96 mm)

Operation

Safety Precautions

E5CN/E5CN-U

Specifications

Ratings

Power supply voltage		No D in model number: 100 to 240 VAC, 50/60 Hz D in model number: 24 VAC, 50/60 Hz; 24 VDC	
Operating voltage range		85% to 110% of rated supply voltage	
Power consumption	E5CN	100 to 240 VAC: 7.5 VA (max.) (E5CN-R2T at 100 VAC: 3.0 VA) 24 VAC/VDC: 5 VA/3 W (max.) (E5CN-R2TD at 24 VAC: 2.7 VA)	
	E5CN-U	100 to 240 VAC: 6 VA (max.) 24 VAC/VDC: 3 VA/2 W (max.) (models with current output: 4 VA/2 W)	
Sensor input		Models with temperature inputs Thermocouple: K, J, T, E, L, U, N, R, S, B, W, or PL II Platinum resistance thermometer: Pt100 or JPt100 Infrared temperature sensor: 10 to 70°C, 60 to 120°C, 115 to 165°C, or 140 to 260°C Voltage input: 0 to 50 mV	
		Models with analog inputs Current input: 4 to 20 mA or 0 to 20 mA Voltage input: 1 to 5 V, 0 to 5 V, or 0 to 10 V	
Input impedance		Current input: 150 Ω max., Voltage input: 1 MΩ min. (Use a 1:1 connection when connecting the ES2-HB.)	
Control method		ON/OFF control or 2-PID control (with auto-tuning)	
Control outputs	Relay output	E5CN	SPST-NO, 250 VAC, 3 A (resistive load), electrical life: 100,000 operations, minimum applicable load: 5 V, 10 mA
		E5CN-U	SPDT, 250 VAC, 3 A (resistive load), electrical life: 100,000 operations, minimum applicable load: 5 V, 10 mA
	Voltage output (for driving SSR)	E5CN E5CN-U	Output voltage: 12 VDC ±15% (PNP), max. load current: 21 mA, with short-circuit protection circuit
	Current output	E5CN	4 to 20 mA DC/0 to 20 mA DC, load: 600 Ω max., resolution: approx. 10,000
Auxiliary outputs	Long-life relay output	E5CN	SPST-NO, 250 VAC, 3 A (resistive load), electrical life: 1,000,000 operations, load power supply voltage: 75 to 250 VAC (DC loads cannot be connected.), minimum applicable load: 5 V, 10 mA, leakage current: 5 mA max. (250 VAC, 60 Hz)
	Number of outputs	1 or 2 max. (Depends on the model.)	
Event inputs	External contact input specifications	Contact input: ON: 1 kΩ max., OFF: 100 kΩ min.	
		Non-contact input: ON: Residual voltage: 1.5 V max., OFF: Leakage current: 0.1 mA max.	
		Current flow: Approx. 7 mA per contact	
External power supply for ES1B		12 VDC ±10%, 20 mA, short-circuit protection circuit provided	
Setting method		Digital setting using front panel keys	
Indication method		11-segment digital display and individual indicators (7-segment display also possible) Character height: PV: 11 mm, SV: 6.5 mm	
Multi SP		Up to four set points (SP0 to SP3) can be saved and selected using event inputs, key operations, or serial communications.	
Bank switching		Not supported	
Other functions		Manual output, heating/cooling control, loop burnout alarm, SP ramp, other alarm functions, heater burnout detection, 40% AT, 100% AT, MV limiter, input digital filter, self-tuning, temperature input shift, run/stop, protection functions, control output ON/OFF counter, extraction of square root, MV change rate limit, logic operations, PV/SV status display, simple program, automatic cooling coefficient adjustment	
Ambient operating temperature		-10 to 55°C (with no condensation or icing), for 3-year warranty: -10 to 50°C	
Ambient operating humidity		25% to 85%	
Storage temperature		-25 to 65°C (with no condensation or icing)	

E5CN
E5CN-U (48 x 48 mm)

E5AN (96 x 96 mm)
E5EN (48 x 96 mm)

E5CN-H (48 x 48 mm)

E5AN-H (96 x 96 mm)
E5EN-H (48 x 96 mm)

Operation

Safety Precautions

Input Ranges

Thermocouple/Platinum Resistance Thermometer (Universal Inputs)

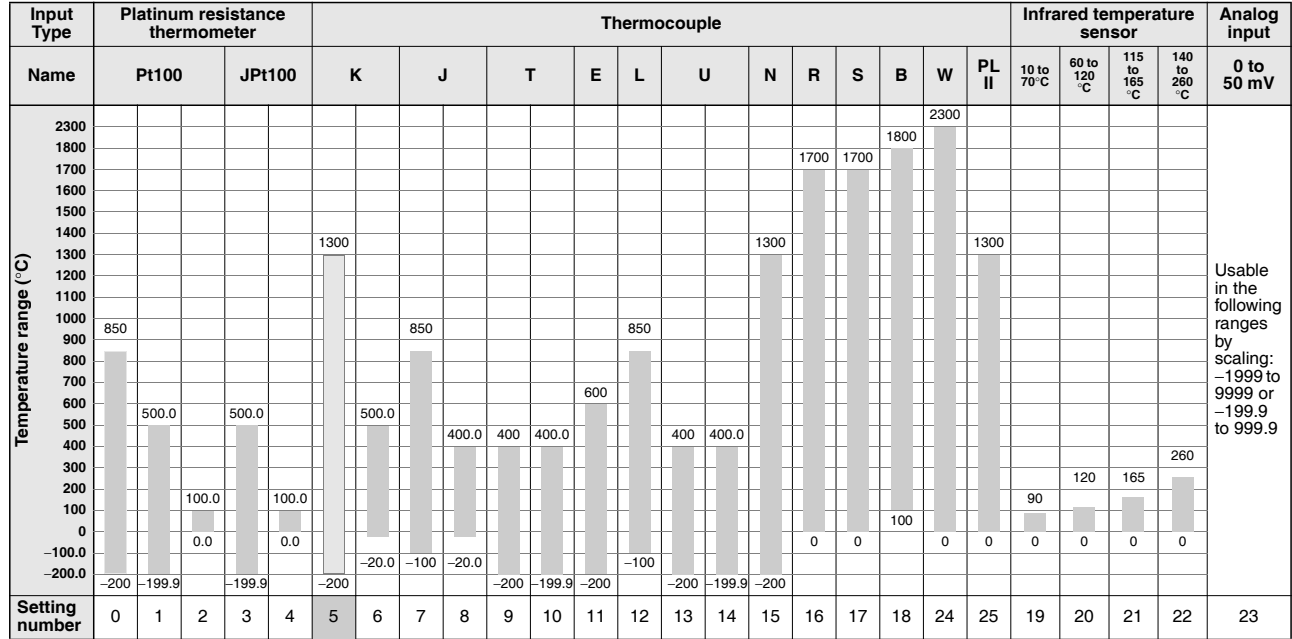

Shaded settings are the default settings.

The applicable standards for the input types are as follows:

K, J, T, E, N, R, S, B: JIS C 1602-1995, IEC 584-1

L: Fe-CuNi, DIN 43710-1985

U: Cu-CuNi, DIN 43710-1985

W: W5Re/W26Re, ASTM E988-1990

JPt100: JIS C 1604-1989, JIS C 1606-1989

Pt100: JIS C 1604-1997, IEC 751

PL II: According to Platinel II electromotive force charts from BASF (previously Engelhard)

Models with Analog Inputs

Input Type	Current		Voltage		
Input specification	4 to 20mA	0 to 20 mA	1 to 5 V	0 to 5 V	0 to 10 V
Setting range	Usable in the following ranges by scaling: -1999 to 9999, -199.9 to 999.9, -19.99 to 99.99 or -1.999 to 9.999				
Setting number	0	1	2	3	4

Shaded settings are the default settings.

E5CN
E5CN-U (48 x 48 mm)

E5AN (96 x 96 mm)
E5EN (48 x 96 mm)

E5CN-H (48 x 48 mm)

E5AN-H (96 x 96 mm)
E5EN-H (48 x 96 mm)

Operation

Safety Precautions

E5CN/E5CN-U

E5CN
E5CN-U (48 x 48 mm)

E5AN (96 x 96 mm)
E5EN (48 x 96 mm)

E5CN-H (48 x 48 mm)

E5AN-H (96 x 96 mm)
E5EN-H (48 x 96 mm)







Operation

Safety Precautions

Alarm Outputs

Each alarm can be independently set to one of the following 13 alarm types. The default is 2: *Upper limit*. Auxiliary outputs are allocated for alarms. ON delays and OFF delays (0 to 999 s) can also be specified.

Note: For models with heater burnout, SSR failure, and heater overcurrent detection, alarm 1 will be an OR output of the alarm selected from the following alarm types and the alarms for heater burnout, SSR failure, and heater overcurrent. To output only a heater burnout alarm, SSR failure alarm, and heater overcurrent alarm for alarm 1, set the alarm type to 0 (i.e., no alarm function).

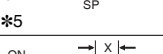
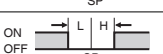
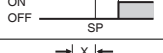
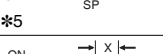
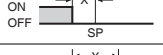
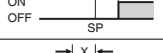
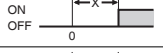
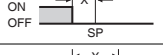
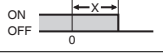
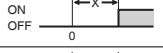
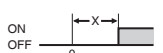
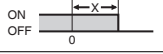
Set value	Alarm type	Alarm output operation	
		When X is positive	When X is negative
0	Alarm function OFF	Output OFF	
1 *1	Upper- and lower-limit	ON OFF 	*2
2	Upper limit	ON OFF 	ON OFF 
3	Lower limit	ON OFF 	ON OFF 
4 *1	Upper- and lower-limit range	ON OFF 	*3
5 *1	Upper- and lower-limit with standby sequence	ON OFF 	*4
6	Upper-limit with standby sequence	ON OFF 	ON OFF 
7	Lower-limit with standby sequence	ON OFF 	ON OFF 
8	Absolute-value upper-limit	ON OFF 	ON OFF 
9	Absolute-value lower-limit	ON OFF 	ON OFF 
10	Absolute-value upper-limit with standby sequence	ON OFF 	ON OFF 
11	Absolute-value lower-limit with standby sequence	ON OFF 	ON OFF 
12	LBA (for alarm 1 only)	---	---
13	PV change rate alarm	---	---

*1. With set values 1, 4 and 5, the upper and lower limit values can be set independently for each alarm type, and are expressed as "L" and "H."

*2. Set value: 1, Upper- and lower-limit alarm

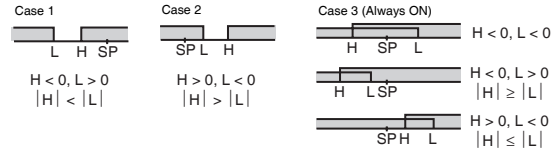

*3. Set value: 4, Upper- and lower-limit range

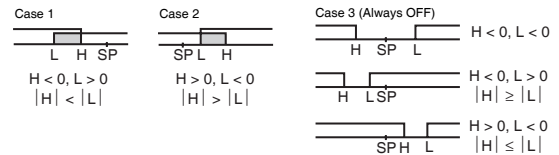

*4. Set value: 5, Upper- and lower-limit with standby sequence
For Upper- and Lower-Limit Alarm Described Above

- Case 1 and 2
Always OFF when the upper-limit and lower-limit hysteresis overlaps.
 - Case 3: Always OFF
- *5. Set value: 5, Upper- and lower-limit with standby sequence
Always OFF when the upper-limit and lower-limit hysteresis overlaps.

Characteristics

Indication accuracy		Thermocouple: *1 Terminal block models (E5CN): ($\pm 0.3\%$ of indicated value or $\pm 1^\circ\text{C}$, whichever is greater) ± 1 digit max. Plug-in models (E5CN-U): ($\pm 1\%$ of indicated value or $\pm 2^\circ\text{C}$, whichever is greater) ± 1 digit max. Platinum resistance thermometer input: Terminal block models (E5CN) and plug-in models (E5CN-U): ($\pm 0.2\%$ of indicated value or $\pm 0.8^\circ\text{C}$, whichever is greater) ± 1 digit max. Analog input: Terminal block models (E5CN) and plug-in models (E5CN-U): $\pm 0.2\%$ FS ± 1 digit max. CT input: Terminal block models (E5CN): $\pm 5\%$ FS ± 1 digit max.
Influence of temperature *2		Thermocouple input (R, S, B, W, PL II): Terminal block models (E5CN): ($\pm 1\%$ of PV or $\pm 10^\circ\text{C}$, whichever is greater) ± 1 digit max. Plug-in models (E5CN-U): ($\pm 2\%$ of PV or $\pm 10^\circ\text{C}$, whichever is greater) ± 1 digit max. Other thermocouple input: *3 Terminal block models (E5CN): ($\pm 1\%$ of PV or $\pm 4^\circ\text{C}$, whichever is greater) ± 1 digit max. Plug-in models (E5CN-U): ($\pm 2\%$ of PV or $\pm 4^\circ\text{C}$, whichever is greater) ± 1 digit max.
Influence of voltage *2		Platinum resistance thermometer input: Terminal block models (E5CN) and plug-in models (E5CN-U): ($\pm 1\%$ of PV or $\pm 2^\circ\text{C}$, whichever is greater) ± 1 digit max. Analog input: Terminal block models (E5CN) and plug-in models (E5CN-U): ($\pm 1\%$ FS) ± 1 digit max.
Input sampling period		250 ms
Hysteresis		Models with thermocouple/platinum resistance thermometer input (universal input): 0.1 to 999.9 EU (in units of 0.1 EU) *4 Models with analog input: 0.01 to 99.99% FS (in units of 0.01% FS)
Proportional band (P)		Models with thermocouple/platinum resistance thermometer input (universal input): 0.1 to 999.9 EU (in units of 0.1 EU) *4 Models with analog input: 0.1 to 999.9% FS (in units of 0.1% FS)
Integral time (I)		0 to 3999 s (in units of 1 s)
Derivative time (D)		0 to 3999 s (in units of 1 s) *5
Control period		0.5, 1 to 99 s (in units of 1 s)
Manual reset value		0.0 to 100.0% (in units of 0.1%)
Alarm setting range		-1999 to 9999 (decimal point position depends on input type)
Affect of signal source resistance		Thermocouple: $0.1^\circ\text{C}/\Omega$ max. (100 Ω max.) Platinum resistance thermometer: $0.1^\circ\text{C}/\Omega$ max. (10 Ω max.)
Insulation resistance		20 M Ω min. (at 500 VDC)
Dielectric strength		2,300 VAC, 50 or 60 Hz for 1 min (between terminals with different charge)
Vibration resistance	Malfunction	10 to 55 Hz, 20 m/s ² for 10 min each in X, Y, and Z directions
	Destruction	10 to 55 Hz, 0.75-mm single amplitude for 2 hrs each in X, Y, and Z directions
Shock resistance	Malfunction	100 m/s ² , 3 times each in X, Y, and Z directions
	Destruction	300 m/s ² , 3 times each in X, Y, and Z directions
Weight	E5CN	Controller: Approx. 150 g, Mounting Bracket: Approx. 10 g
	E5CN-U	Controller: Approx. 110 g, Mounting Bracket: Approx. 10 g
Degree of protection	E5CN	Front panel: IP66, Rear case: IP20, Terminals: IP00
	E5CN-U	Front panel: IP50, Rear case: IP20, Terminals: IP00
Memory protection		Non-volatile memory (number of writes: 1,000,000 times)
Setup Tool		CX-Thermo version 4.0 or higher
Setup Tool port		Provided on the bottom of the E5CN. Use this port to connect a computer to the E5CN when using the Setup Tool. An E58-CIFQ1 USB-Serial Conversion Cable is required to connect the computer to the E5CN. *6
Standards	Approved standards *7	UL 61010-1, CSA C22.2 No. 1010-1
	Conformed standards	EN 61010-1 (IEC 61010-1): Pollution level 2, overcurrent category II
EMC		EMI: Radiated Interference Electromagnetic Field Strength: EN 61326 Noise Terminal Voltage: EN 55011 Group 1, class A EMS: ESD Immunity: EN 61326 EN 61000-4-2 Electromagnetic Field Immunity: EN 61000-4-3 Burst Noise Immunity: EN 61000-4-4 Conducted Disturbance Immunity: EN 61000-4-6 Surge Immunity: EN 61000-4-5 Power Frequency Magnetic Field Immunity: EN 61000-4-8 Voltage Dip/Interrupting Immunity: EN 61000-4-11

*1. The indication accuracy of K thermocouples in the -200 to 1300°C range, T and N thermocouples at a temperature of -100°C max., and U and L thermocouples at any temperatures is $\pm 2^\circ\text{C} \pm 1$ digit max. The indication accuracy of the B thermocouple at a temperature of 400°C max. is not specified. The indication accuracy of B thermocouples in the 400 to 800°C range is $\pm 3^\circ\text{C}$ max. The indication accuracy of the R and S thermocouples at a temperature of 200°C max. is $\pm 3^\circ\text{C} \pm 1$ digit max. The indication accuracy of W thermocouples is ± 0.3 of PV or $\pm 3^\circ\text{C}$, whichever is greater, ± 1 digit max. The indication accuracy of PL II thermocouples is ± 0.3 of PV or $\pm 2^\circ\text{C}$, whichever is greater, ± 1 digit max.

*2. Ambient temperature: -10°C to 23°C to 55°C , Voltage range: -15% to 10% of rated voltage

*3. K thermocouple at -100°C max.: $\pm 10^\circ$ max.

*4. "EU" stands for Engineering Unit and is used as the unit after scaling. For a temperature sensor, the EU is $^\circ\text{C}$ or $^\circ\text{F}$.

*5. When robust tuning (RT) is ON, the differential time is 0.0 to 999.9 (in units of 0.1 s).

*6. External communications (RS-485) and cable communications for the Setup Tool can be used at the same time.

*7. The E5CN-U plug-in model is certified for UL listing only when used together with the OMRON P2CF-11 or P2CF-11-E Socket. The P3GA-11 is not certified for UL listing.

E5CN
E5CN-U (48 x 48 mm)E5AN (96 x 96 mm)
E5EN (48 x 96 mm)

E5CN-H (48 x 48 mm)

E5AN-H (96 x 96 mm)
E5EN-H (48 x 96 mm)

Operation

Safety Precautions

E5CN/E5CN-U

E5CN
E5CN-U (48 x 48 mm)

USB-Serial Conversion Cable

Applicable OS	Windows 2000, XP, or Vista
Applicable software	Thermo Mini, CX-Thermo version 4.0 or higher
Applicable models	E5AN/E5EN/E5CN/E5CN-U/E5AN-H/ E5EN-H/E5CN-H
USB interface standard	Conforms to USB Specification 1.1.
DTE speed	38400 bps
Connector specifications	Computer: USB (type A plug) Temperature Controller: Setup Tool port (on bottom of Controller)
Power supply	Bus power (Supplied from USB host controller.)
Power supply voltage	5 VDC
Current consumption	70 mA
Ambient operating temperature	0 to 55°C (with no condensation or icing)
Ambient operating humidity	10% to 80%
Storage temperature	-20 to 60°C (with no condensation or icing)
Storage humidity	10% to 80%
Altitude	2,000 m max.
Weight	Approx. 100 g

Note: A driver must be installed in the personal computer. Refer to installation information in the operation manual for the Conversion Cable.

E5AN (96 x 96 mm)
E5EN (48 x 96 mm)

E5CN-H (48 x 48 mm)

Communications Specifications

Transmission line connection method	RS-485: Multipoint
Communications	RS-485 (two-wire, half duplex)
Synchronization method	Start-stop synchronization
Protocol	CompoWay/F, SYSWAY, or Modbus
Baud rate	1200, 2400, 4800, 9600, 19200, 38400, or 57600 bps
Transmission code	ASCII
Data bit length *	7 or 8 bits
Stop bit length *	1 or 2 bits
Error detection	Vertical parity (none, even, odd) Frame check sequence (FCS) with SYSWAY Block check character (BCC) with CompoWay/F or CRC-16 Modbus
Flow control	None
Interface	RS-485
Retry function	None
Communications buffer	217 bytes
Communications response wait time	0 to 99 ms Default: 20 ms

* The baud rate, data bit length, stop bit length, and vertical parity can be individually set using the Communications Setting Level.

E5AN-H (96 x 96 mm)
E5EN-H (48 x 96 mm)

Operation

Safety Precautions

Current Transformer (Order Separately) Ratings

Dielectric strength	1,000 VAC for 1 min
Vibration resistance	50 Hz, 98 m/s ²
Weight	E54-CT1: Approx. 11.5 g, E54-CT3: Approx. 50 g
Accessories (E54-CT3 only)	Armatures (2) Plugs (2)

Heater Burnout Alarms, SSR Failure Alarms, and Heater Overcurrent Alarms

CT input (for heater current detection)	Models with detection for single-phase heaters: One input Models with detection for single-phase or three-phase heaters: Two inputs
Maximum heater current	50 A AC
Input current indication accuracy	±5% FS ±1 digit max.
Heater burnout alarm setting range *1	0.1 to 49.9 A (in units of 0.1 A) Minimum detection ON time: 100 ms
SSR failure alarm setting range *2	0.1 to 49.9 A (in units of 0.1 A) Minimum detection OFF time: 100 ms
Heater overcurrent alarm setting range *3	0.1 to 49.9 A (in units of 0.1 A) Minimum detection ON time: 100 ms

- *1. For heater burnout alarms, the heater current will be measured when the control output is ON, and the output assigned to the alarm 1 function will turn ON if the heater current is lower than the set value (i.e., heater burnout detection current value).
- *2. For SSR failure alarms, the heater current will be measured when the control output is OFF, and the output assigned to the alarm 1 function will turn ON if the heater current is higher than the set value (i.e., SSR failure detection current value).
- *3. For heater overcurrent alarms, the heater current will be measured when the control output is ON, and the output assigned to the alarm 1 function will turn ON if the heater current is higher than the set value (i.e., heater overcurrent detection current value).

Electrical Life Expectancy Curve for Relays (Reference Values)

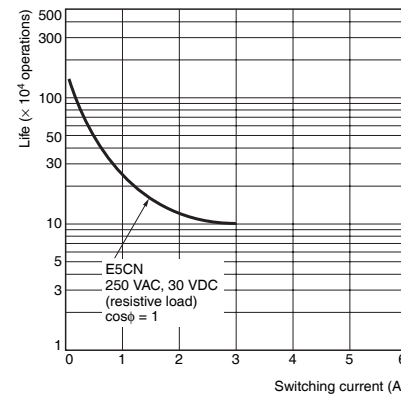

Note: Do not connect a DC load to a Controller with a Long-life Relay Output.

External Connections

- A voltage output (control output, for driving SSR) is not electrically insulated from the internal circuits. When using a grounding thermocouple, do not connect any of the control output terminals to ground. (If the control output terminals are connected to ground, errors will occur in the measured temperature values as a result of leakage current.)
- Consult with your OMRON representative before using the external power supply for the ES1B for any other purpose.

E5CN

Controllers

Control output 1

- Long-life relay output
- 250 VAC, 3 A (resistive load)
- Relay output
- 250 VAC, 3 A (resistive load)
- Voltage output (for driving SSR)
- 12 VDC, 21 mA
- Current output
- 0 to 20 mA DC
- 4 to 20 mA DC
- Load: 600 Ω max.

Control output 2

- Voltage output (for driving SSR)
- 12 VDC, 21 mA

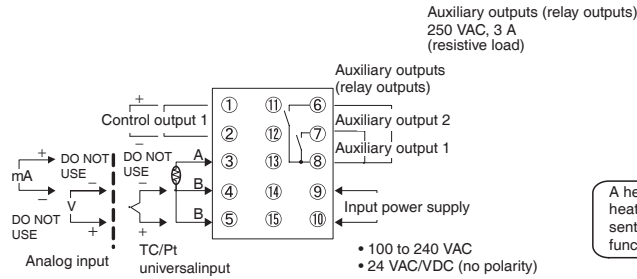

A heater burnout alarm, heater short alarm, heater overcurrent alarm, or input alarm is sent to the output to which the alarm 1 function is assigned.

Option Units

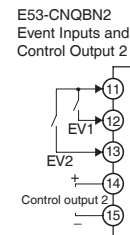
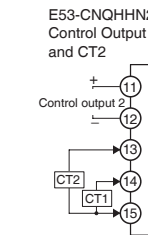
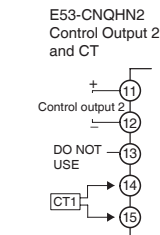
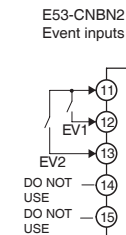
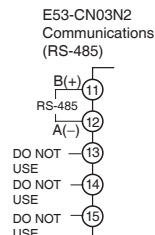
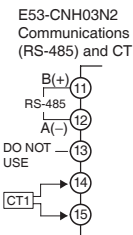
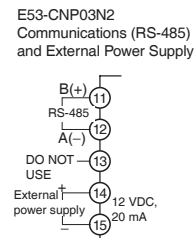
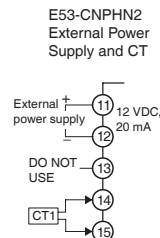
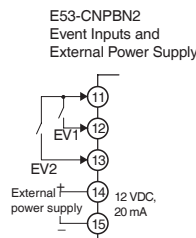
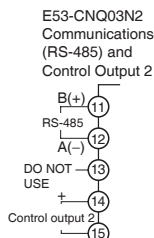
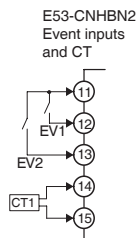
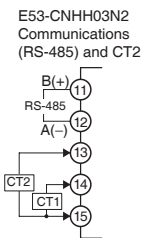

E5CN-U

Control output 1

- Relay output (three terminals used) SPDT, 250 VAC, 3 A (resistive load)
- Voltage output (for driving SSR)
- 12 VDC, 21 mA
- Current output
- 4 to 20 mA DC
- 0 to 20 mA DC
- Load: 600 W max.

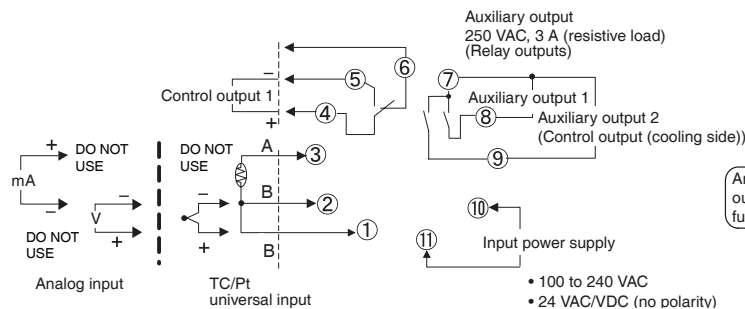

An input error is sent to the output to which the alarm 1 function is assigned.

Note: For the Wiring Socket, purchase the P2CF-11 or PG3A-11 separately.

E5CN
E5CN-U (48 x 48 mm)

E5AN (96 x 96 mm)
E5EN (48 x 96 mm)

E5CN-H (48 x 48 mm)

E5AN-H (96 x 96 mm)
E5EN-H (48 x 96 mm)

Operation

Safety Precautions

E5CN/E5CN-U

Nomenclature

E5CN
E5CN-U

The front panel is the same for the E5CN and E5CN-U.

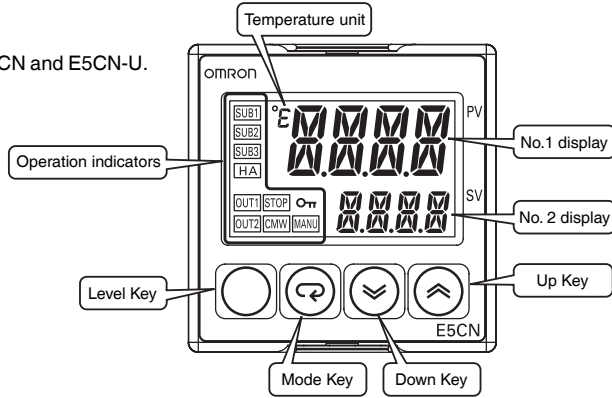

Dimensions

(Unit: mm)

E5CN
Terminal Models

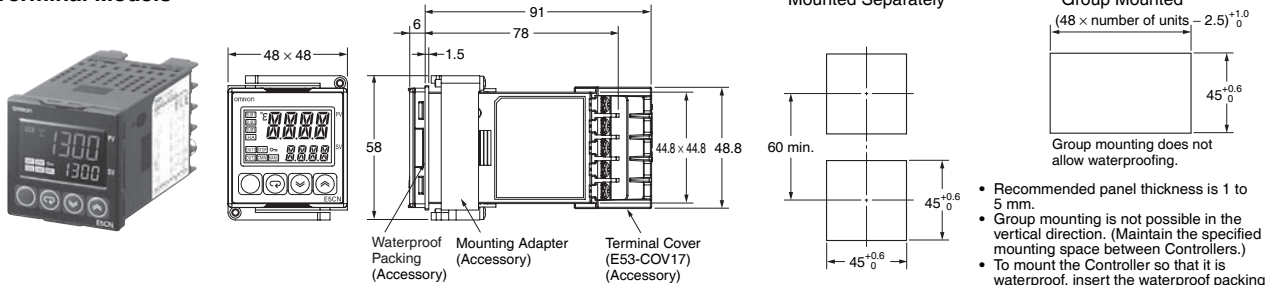

Note: The terminal block cannot be removed.

E5CN-U
Plug-in Models

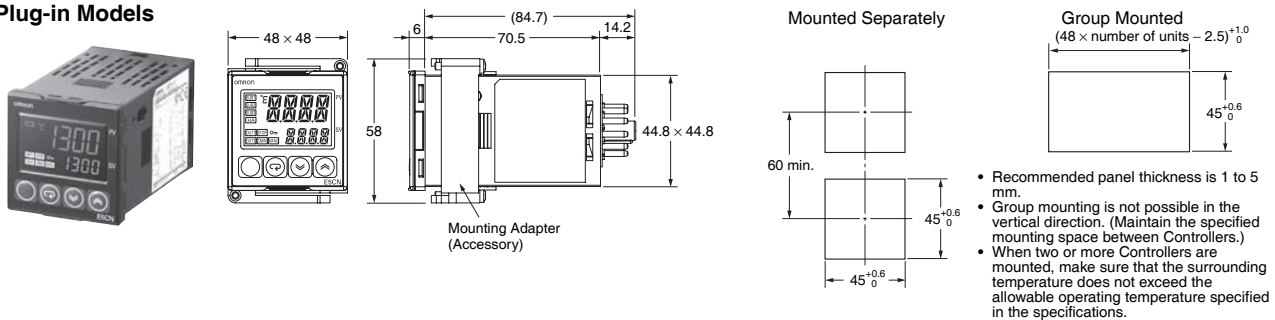

Accessories (Order Separately)

USB-Serial Conversion Cable

E58-CIFQ1

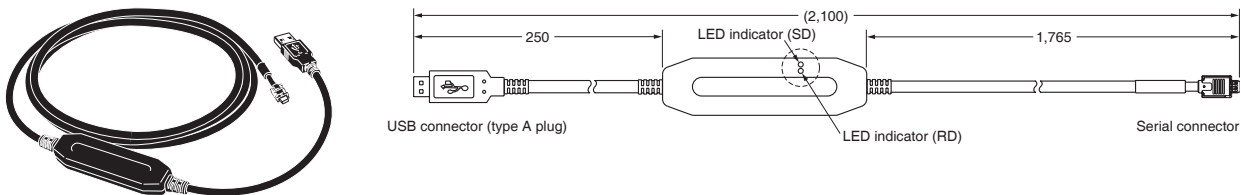

E5CN
E5CN-U (48 x 48 mm)

E5AN (96 x 96 mm)
E5EN (48 x 96 mm)

E5CN-H (48 x 48 mm)

E5AN-H (96 x 96 mm)
E5EN-H (48 x 96 mm)

Operation

Safety Precautions

Terminal Cover E53-COV17

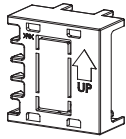

Note: The E53-COV10 cannot be used.

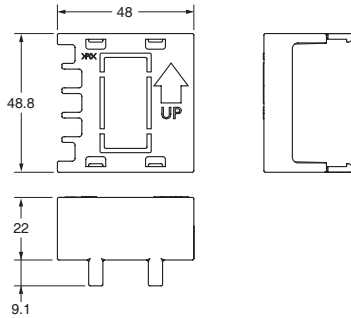

Waterproof Packing Y92S-29 (for DIN 48 × 48)

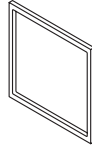

Order the Waterproof Packing separately if it becomes lost or damaged.

The Waterproof Packing can be used to achieve an IP66 degree of protection.

(Deterioration, shrinking, or hardening of the waterproof packing may occur depending on the operating environment. Therefore, periodic replacement is recommended to ensure the level of waterproofing specified in IP66. The time for periodic replacement depends on the operating environment. Be sure to confirm this point at your site. Consider one year a rough standard. OMRON shall not be liable for the level of water resistance if the customer does not perform periodic replacement.)

The Waterproof Packing does not need to be attached if a waterproof structure is not required.

Current Transformers

E54-CT1

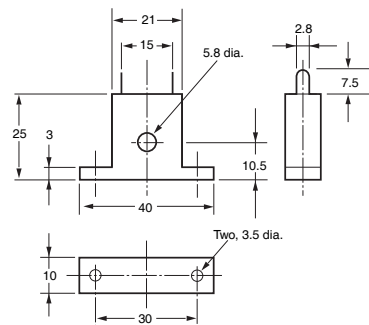
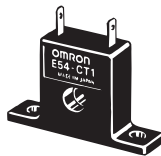

E54-CT1

Thru-current (Io) vs. Output Voltage (Eo) (Reference Values)

Maximum continuous heater current: 50 A (50/60 Hz)
Number of windings: 400±2
Winding resistance: 18±2 Ω

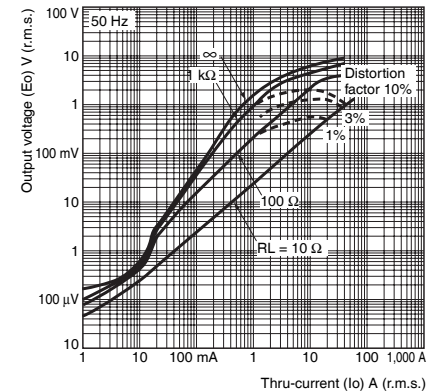

E54-CT3

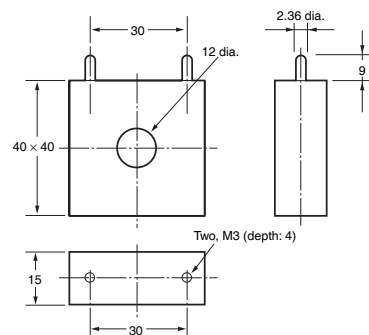
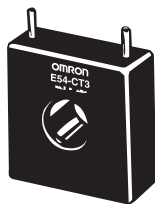

E54-CT3

Thru-current (Io) vs. Output Voltage (Eo) (Reference Values)

Maximum continuous heater current: 120 A (50/60 Hz)
(Maximum continuous heater current for the Temperature Controller is 50 A.)
Number of windings: 400±2
Winding resistance: 8±0.8 Ω

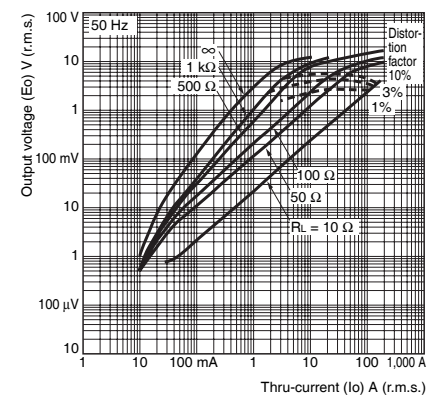

E54-CT3 Accessory

• Armature

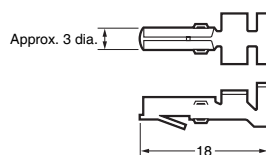

• Plug

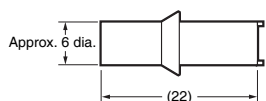

Connection Example

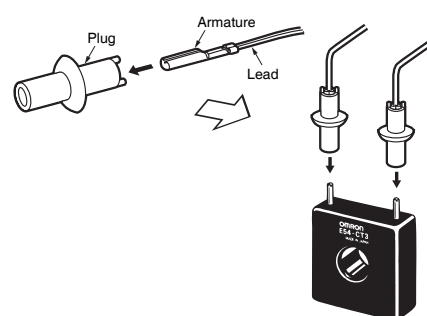

E5CN
E5CN-U (48 x 48 mm)

E5AN (96 x 96 mm)
E5EN (48 x 96 mm)

E5CN-H (48 x 48 mm)

E5AN-H (96 x 96 mm)
E5EN-H (48 x 96 mm)

Operation

Safety Precautions

E5CN/E5CN-U

E5CN
E5CN-U (48 x 48 mm)

Adapter

Y92F-45 Note: Use this Adapter when the panel has already been prepared for the E5B□.

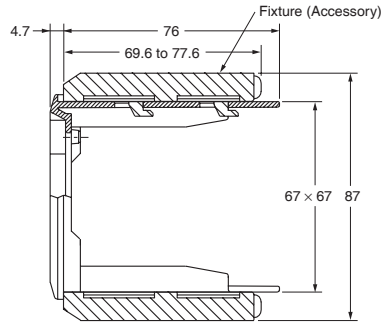
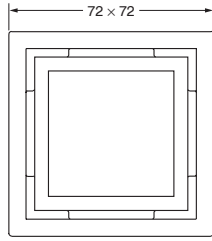
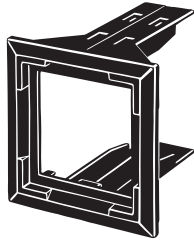

E5AN (96 x 96 mm)
E5EN (48 x 96 mm)

Mounted to E5CN

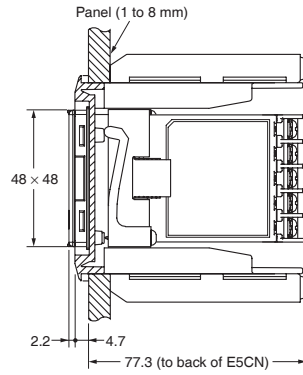
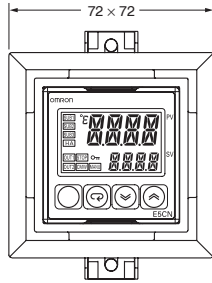
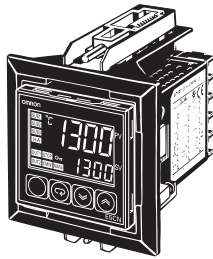

E5CN-H (48 x 48 mm)

E5CN-U Wiring Socket

E5AN-H (96 x 96 mm)
E5EN-H (48 x 96 mm)

Front-connecting Socket

P2CF-11

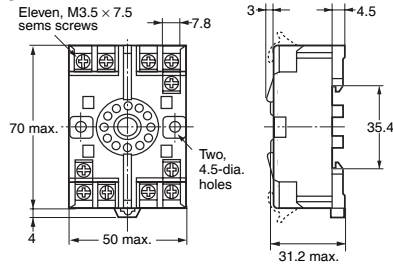
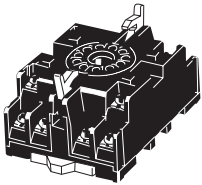

Terminal Layout/Internal Connections (Top View)

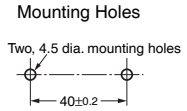
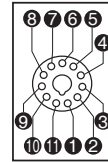

Note: Can also be mounted to a DIN track.

Note: A model with finger protection (P2CF-11-E) is also available.

Operation

Back-connecting Socket

P3GA-11

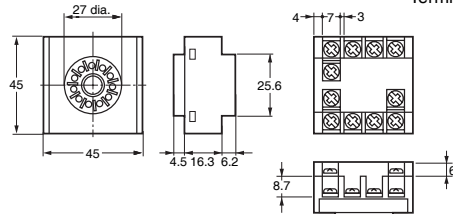
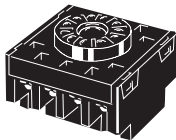

Terminal Layout/Internal Connections (Bottom View)

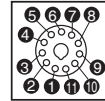

Note: 1. Using any other sockets will adversely affect accuracy. Use only the specified sockets.
2. A Protective Cover for finger protection (Y92A-48G) is also available.

Safety Precautions